

Data Sheet



Article number: 20605015

Description: E+G Ball transfer unit
GN 509-15-SNI

Measures

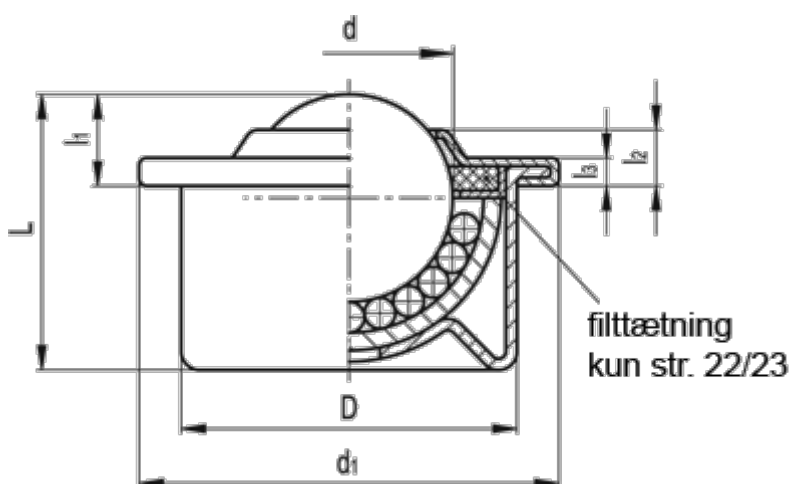

d	= 15.8
D	= 24
d1	= 31
L +/-0.3	= 21.0
l1 +/-0,3	= 9.5
l2 +/-0.3	= 5
l3	= 2.5
Max load (N)	= 300

Weight (g) = 40